

Low Pressure Line Regulators 4403 Series

Application

The 4403 series regulators provide very sensitive control of a variety of gases at low pressures. The large molded diaphragm assures responsive regulation with inlet pressures up to 250 PSI.

Features

- Large molded diaphragm provides highly sensitive and accurate low pressure control.
- Zinc body and bonnet resist corrosion and provide longer life.
- Teflon seat disc, teflon faced diaphragms, and stainless steel nozzles make the T4403J regulators compatible with a variety of gases.
- LV4403C2H42 features integral relief valve set at 3 psig.
- Adjusting screw is concealed by a plastic cap which helps prevent pressure adjustments by unauthorized personnel.
- Working temperature range is -40°F to +165°F.
- Not suitable for oxygen applications

Materials

Body	Zinc
Bonnet	Zinc
Diaphragm	T4403J, 4403W, S4, T4, U4 Teflon Faced Buna N
4403WP4, R4	Buna N
(LV4403C)	Integrated Fabric and Synthetic Rubber
Spring	Steel
Seat (T4403J)	PTFE
(4403W) (LV4403C)	Buna N
Nozzle (T4403J)	Stainless Steel
(4403W, LV4403C)	Brass

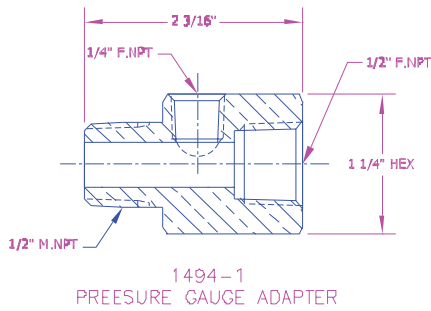

4403

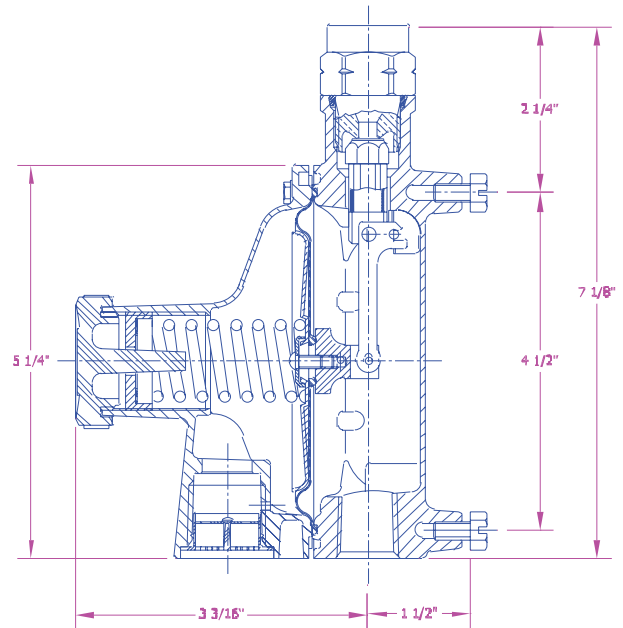

Ordering Information

Part Number	Inlet Connection	Outlet Connection	Factory Delivery Pressure*	Delivery Adjustment Range	Relief Setting
4403W-P4	1/2" F.NPT	1/2" F.NPT	6" w.c.	3.5 - 6" w.c.	None
4403W-R4			25" w.c.	15 - 28" w.c.	
4403W-S4			5 PSIG	1 - 5 PSIG	
4403W-T4			10 PSIG	5 - 10 PSIG	
4403W-U4			15 PSIG	10 - 15 PSIG	
LV4403C2H42	1/4" F.NPT	1/2" F.NPT	1.5 PSIG	1.5 PSIG	3 PSIG ± 20%
T4403JS2			5 PSIG	1 - 5 PSIG	None
T4403JT2			10 PSIG	5 - 10 PSIG	

* Based on 50 PSIG inlet pressure. LV4403C2H42 based on 100 PSIG inlet pressure.